

Data sheet | Item number: 207-1331

Gelbox; for cables; Branch; with gel; 221, 2273 Series; without splicing connectors; Size 1; gray

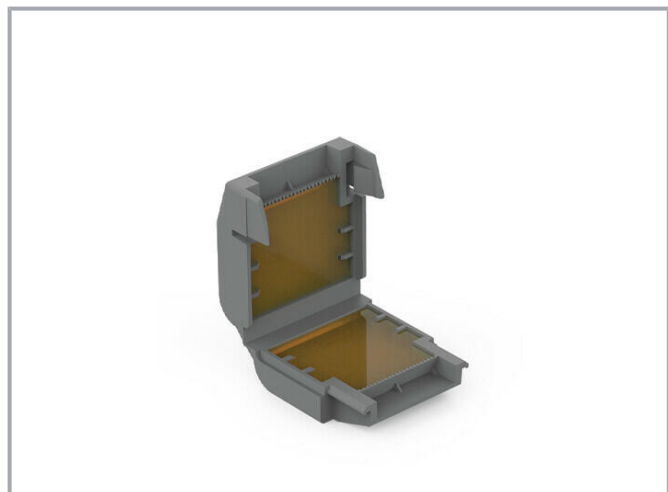

www.wago.com/207-1331



Subject to changes. Please also observe the further product documentation!

WAGO Kontakttechnik GmbH & Co. KG
Hansastr. 27
32423 Minden
Phone: +49571 887-0 | Fax: +49571 887-169
Email: info.de@wago.com | Web: www.wago.com

Do you have any questions about our products?
We are always happy to take your call at +49 (571) 887-44222.



Item description

Note on Packaging Unit (PU) and Subpackaging Unit (SPU):

If you order a full PU, you will receive our eco-friendly, sustainable cardboard blisters packed in a shelf-ready box.

If you order a quantity smaller than a full PU, you will receive the eco-friendly, sustainable cardboard blisters without a shelf-ready box.

Please note the system description for the splicing connectors that can be used.

The Benefits for You:

- Easy, fast and safe to use
- Can be used immediately and accessed again later
- Silicon-free
- Label-free
- Suitable for indefinite storage
- The complete system consisting of Gelboxes and WAGO connectors has been VDE-tested and IPX8-certified.

Data

Connection data

Actuation type	Locking system
----------------	----------------

Physical data

Width	33.6 mm / 1.323 inch
Height	17.8 mm / 0.701 inch
Depth	32 mm / 1.26 inch

Mechanical data

Mounting type	Flying leads
Protection type	IPx8 (2m/2h) per 60529

Material data

Color	gray
Housing material	Polypropylene
Weight	12.7 g

Environmental requirements

Surrounding air temperature (operation)	-55 ... 85 °C
Surrounding air temperature (storage)	0 ... 40 °C

Subject to changes. Please also observe the further product documentation!

WAGO Kontakttechnik GmbH & Co. KG
 Hansastr. 27
 32423 Minden
 Phone: +49571 887-0 | Fax: +49571 887-169
 Email: info.de@wago.com | Web: www.wago.com

Do you have any questions about our products?
 We are always happy to take your call at +49 (571) 887-44222.

Commercial data

Packaging type	BOX
Country of origin	IT
GTIN	4055143997799
Customs tariff number	85389099990

Approvals / Certificates

Country specific Approvals

Logo	Approval	Additional Approval Text	Certificate name
	VDE VDE Prüf- und Zertifizierungsinstitut	EN 60998	400051938

Downloads

Documentation

Additional Information

Technical explanations	2019-04-03	pdf 2.2 MB	Download
------------------------	------------	---------------	----------

System Description

System Description 207 Series Gel boxes		pdf 1.1 MB	Download
---	--	---------------	----------

Environmental Product Compliance

Compliance Search

Environmental Product Compliance 207-1331 Gelbox; for cables; Branch; with gel; 221, 2273 Series; without splicing connectors; Size 1; gray	URL	Download
---	-----	----------

Installation Notes

Installation

Subject to changes. Please also observe the further product documentation!



Gelbox öffnen.

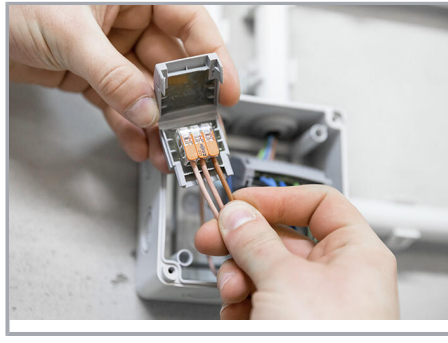

Place the wired connector in the Gelbox.

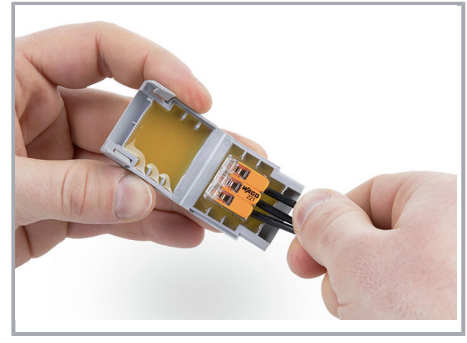

Place the wired connector in the Gelbox.

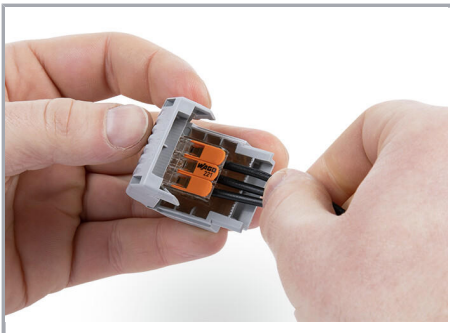

Close the Gelbox.

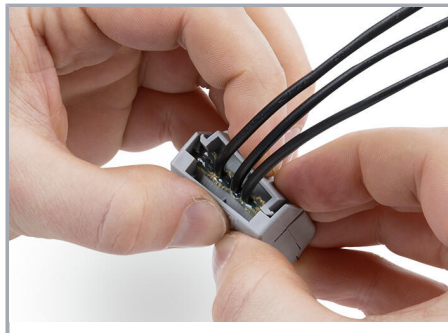

Close latch securely.

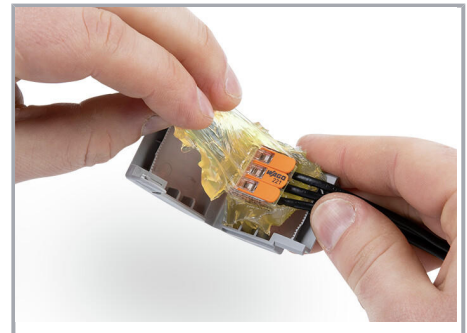

Re-accessible:

- Open the Gelbox.
- Remove the gel.
- Rewire with new components.



Lift the flap and pull the cover perforation forward.



Press in the perforation on the sides.



Tear off the cover from the perforation.

Subject to changes. Please also observe the further product documentation!



As a counter display: Bend the rear flap at the fold, straighten it and fix it in the cardboard cut-out



If the flap is not required, tear off from the perforation.

Subject to changes. Please also observe the further product documentation!